

**Yi7P/Yi10P**  
**Manual 1.3 en**

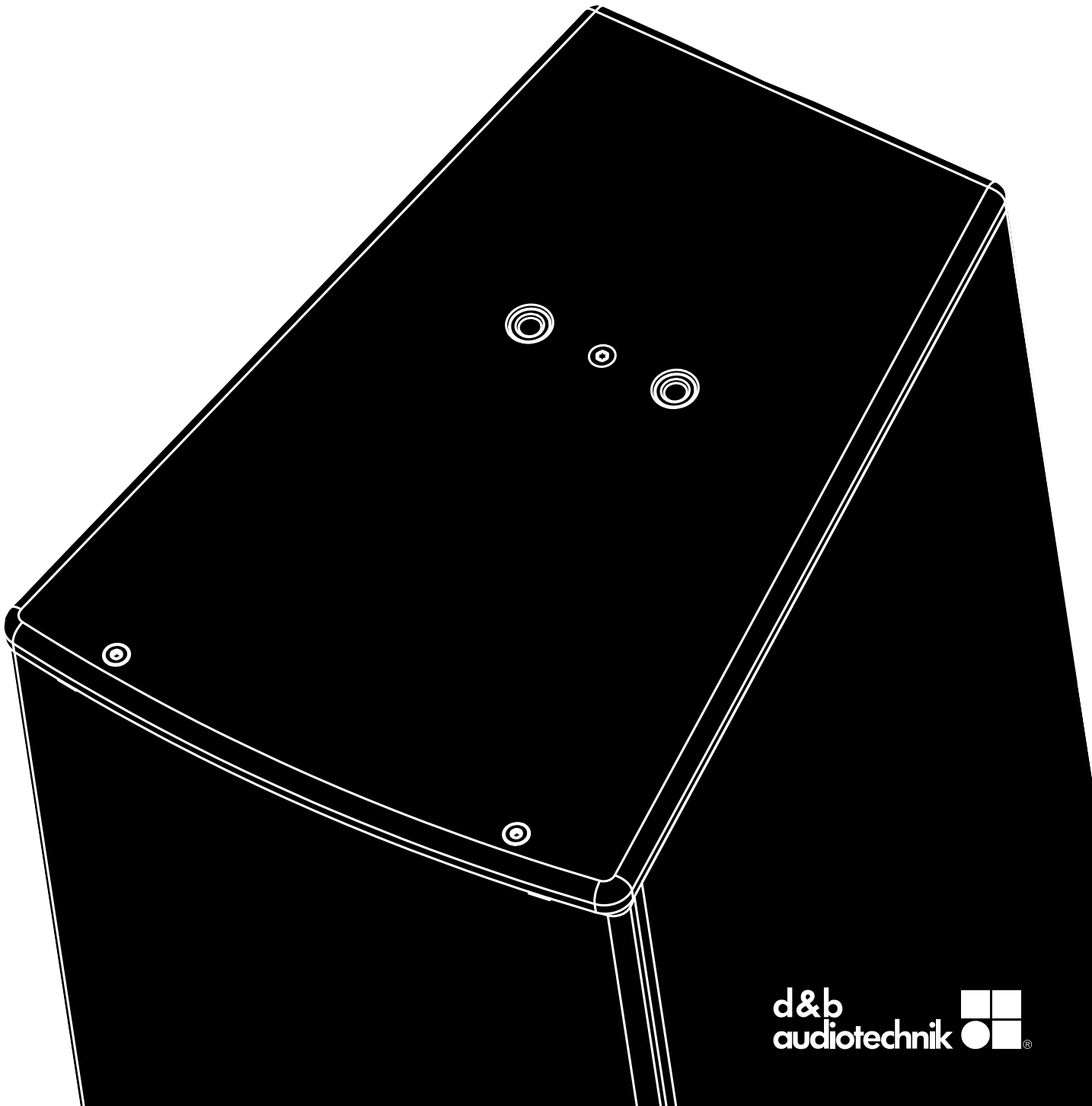

## **General information**

Yi7P/Yi10P Manual

Version: 1.3 en, 10/2018, D2711.EN .01

Copyright © 2018 by d&b audiotechnik GmbH; all rights reserved.

**Keep this document with the product or in a safe place so that it is available for future reference.**

We recommend you to regularly check the d&b website for the latest version of this document.

When reselling this product, hand over this document to the new owner.

If you supply d&b products, please draw the attention of your customers to this document. Enclose the relevant documents with the systems. If you require additional documents for this purpose, you can order them from d&b.

d&b audiotechnik GmbH  
Eugen-Adolf-Strasse 134, D-71522 Backnang, Germany  
T +49-7191-9669-0, F +49-7191-95 00 00

<b>1</b>	<b>Safety precautions</b> .....	<b>4</b>
1.1	Information regarding the use of loudspeakers.....	4
<b>2</b>	<b>Yi7P/Yi10P loudspeaker</b> .....	<b>5</b>
2.1	Product description.....	5
2.2	Connections.....	5
2.3	Operation.....	8
2.3.1	Controller settings.....	8
2.4	Dispersion characteristics.....	9
2.5	Technical specifications.....	11
<b>3</b>	<b>Manufacturer's declarations</b> .....	<b>13</b>
3.1	EU conformity of loudspeakers (CE symbol).....	13
3.1.1	WEEE Declaration (Disposal).....	13

## 1.1 Information regarding the use of loudspeakers

### Potential risk of personal injury

Never stand in the immediate vicinity of loudspeakers driven at a high level. Professional loudspeaker systems are capable of causing a sound pressure level detrimental to human health. Seemingly non-critical sound levels (from approx. 95 dB SPL) can cause hearing damage if people are exposed to it over a long period.

In order to prevent accidents when deploying loudspeakers on the ground or when flown, please take note of the following:

- When setting up the loudspeakers or loudspeaker stands, make sure they are standing on a firm surface. If you place several systems on top of one another, use straps to secure them against movement.
- Only use accessories which have been tested and approved by d&b for assembly and mobile deployment. Pay attention to the correct application and maximum load capacity of the accessories as detailed in our specific "Mounting instructions" or in our "Flying system and Rigging manuals".
- Ensure that all additional hardware, fixings and fasteners used for installation or mobile deployment are of an appropriate size and load safety factor. Pay attention to the manufacturers' instructions and to the relevant safety guidelines.
- Regularly check the loudspeaker housings and accessories for visible signs of wear and tear, and replace them when necessary.
- Regularly check all load bearing bolts in the mounting devices.

### Potential risk of material damage

Loudspeakers produce a static magnetic field even if they are not connected or are not in use. Therefore make sure when erecting and transporting loudspeakers that they are nowhere near equipment and objects which may be impaired or damaged by an external magnetic field. Generally speaking, a distance of 0.5 m (1.5 ft) from magnetic data carriers (floppy disks, audio and video tapes, bank cards, etc.) is sufficient; a distance of more than 1 m (3 ft) may be necessary with computer and video monitors.

## 2 Yi7P/Yi10P loudspeaker

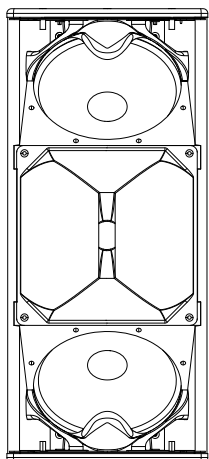

### 2.1 Product description

The Yi7P/Yi10P are passive 2-way loudspeakers housing two 8" LF drivers and a 1.4" HF compression driver with a rotatable CD horn producing a nominal dispersion (h x v) of 75° x 40° or 110° x 40°, respectively. The frequency response extends from 59 Hz to above 18 kHz.

The two 8" neodymium LF drivers are positioned in a dipolar arrangement providing exceptional vertical dispersion control even at lower frequencies.

Specially designed ports with optimized flow characteristics provide a considerably improved, efficient low frequency reproduction.

The cabinets are constructed from marine plywood and have an impact and weather protected PCP (Polyurea Cabinet Protection) finish. The fronts of the loudspeaker cabinets are protected by a rigid metal grill backed by an acoustically transparent foam.

The top and bottom panels of the cabinets are each equipped with a pair of M10 threaded inserts to connect to different rigging accessories such as the Z5398 YP Horizontal bracket, the Z5399 YP Mounting bracket, the Z5354 E8/E12 Flying adapter or the Z5020/25 Flying adapter 02/03.

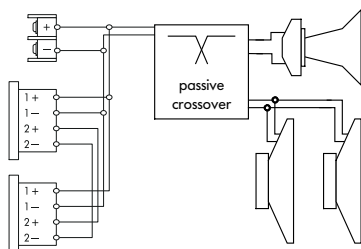

Connector wiring

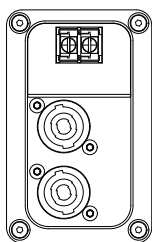

### 2.2 Connections

The cabinets are fitted with a pair of NL4 M connectors and a two pole screw terminal block (ST). All four pins of both NL4 M connectors are wired in parallel. The cabinets use the pin assignments 1+/1-. Pins 2+/2- are designated to active subwoofers.

Pin equivalents of the applicable connector options are listed in the table below.

NL4 M	1+	1-	2+	2-
ST	+	-	n.a.	n.a.

### Fixed cable connection

The Yi7P and Yi10P loudspeakers are each supplied with a cover plate [1] and a rubber grommet feed through [2]. For indoor operation, these items can be used to hide the connector panel, if required. For unprotected outdoor operation, the connector panel must be covered, i.e. both items must be used to achieve an IP degree of protection of IP34.

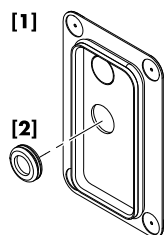

Cover plate and rubber grommet

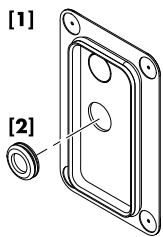

**Step 1**

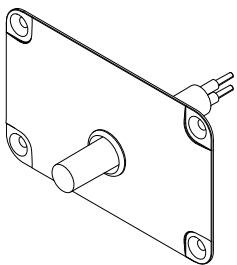

**Step 2**

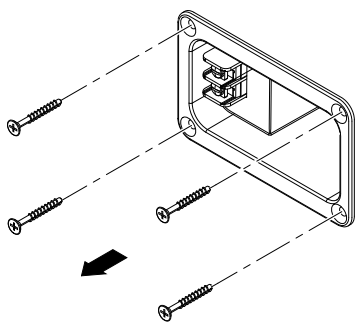

**Step 3**

To install the fixed cable connection, proceed as follows:

**Tools required:** Philips screw driver (#PH2).

1. Remove the knockout opening in the cover plate [1] and attach the rubber grommet [2] correspondingly.
2. Insert the connection cable through the rubber grommet.
3. Undo the four screws of the connector panel.
4. Connect the cable wires to the screw terminal.  
⇒ Observe the correct polarity!
5. Push the cover plate towards the connector panel until it fits into place.
6. Finally fix the cover plate together with the connector panel using all screws.

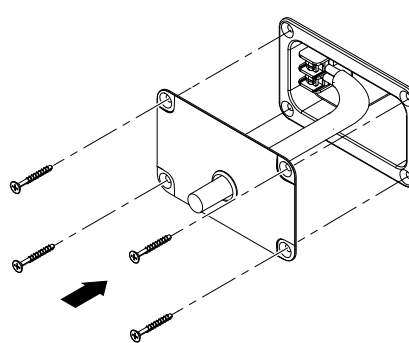

**Step 4/5**

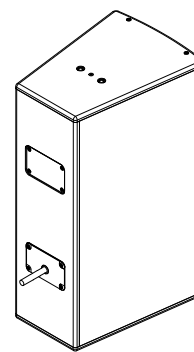

**Step 6**

**Installing the fixed cable connection**

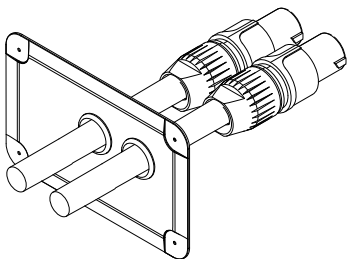

**NL4 cable connection with cover plate [1]**

**NL4 connection with cover plate**

The two NL4 connector sockets of the cabinet's connector panel are located in a recess to allow the use of the cover plate [1] together with NL4 cable connectors, as shown in the graphic opposite.

**Note:** Neutrik NL4FC type connectors must be used for this option.

The cover plate is equipped with two knockout openings to allow daisy chaining of the loudspeaker.

To use the NL4 connection, proceed in the same manner as described in the previous section .

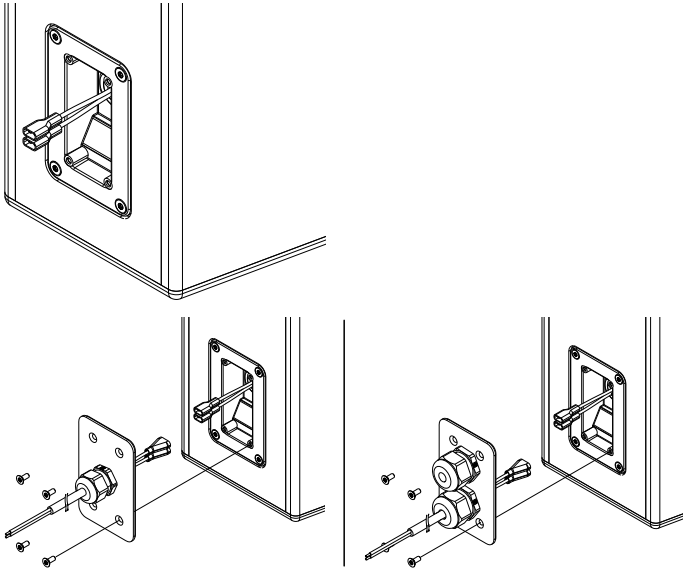

**Faston type connector, male single PG (standard), dual PG (optional)**

### WR option (Weather Resistance)

A number of d&b loudspeakers are available in special options suitable for different types of installed applications and environmental conditions. The following options are available for the Yi7P/Yi10P loudspeaker:

- Weather resistant (WR): This option is suitable for outdoor use. The cabinets have an impact and weather protected black PCP (Polyurea Cabinet Protection) finish.

WR cabinets are equipped with a recessed connector panel including a Faston type connector (2 x 6.3 mm, female). A cover plate which accepts single or dual PG cable glands (Type PG13.5 for cable diameters from 6 - 12 mm) is enclosed, as shown in the graphic opposite.

---

### NOTICE!

---

The WR option enables operation of loudspeakers in changing ambient conditions, however it is not intended to enable permanent, unprotected operation of loudspeakers outdoors.

- Provide an additional cover over the loudspeakers.
  - Aim the cabinets either horizontally or with a downward tilt.
- 

To install the fixed connection cable, please proceed as follows:

**Tools required:** Screw driver (#T20).

**Note:** Observe the correct polarity of the cable  
Brown (+) / Blue (-).

1. Insert the connection cable through the PG screwing and connect the male connector to the female connector.
2. Push the cover plate towards the connector panel until it fits into place.
3. Fix the cover plate to the connector panel using the four countersunk screws.

### d&b LoadMatch

Starting with the D80 amplifier platform, the LoadMatch function enables the amplifier to electrically compensate for the properties of the loudspeaker cable used without the need for an additional sense wire. For applicable loudspeakers, LoadMatch is therefore independent of the connector type used.

## 2.3 Operation

### NOTICE!

Only operate d&b loudspeakers with a correctly configured d&b amplifier, otherwise there is a risk of damaging the loudspeaker components.

#### Applicable d&b amplifiers:

D80/D20/D12/D6/10D/30D.

Application	Setup	Cabinets per channel
<b>Yi7P</b>	Y7P	2
<b>Yi10P</b>	Y10P	2

For applicable amplifiers, the controller setups are available in Dual Channel and Mix TOP/SUB mode.

### 2.3.1 Controller settings

For acoustic adjustment the functions CUT, HFA and CPL can be selected.

#### CUT mode

Set to CUT, the low frequency level is reduced. The cabinets are now configured for use with actively driven d&b subwoofers.

#### HFA mode

In HFA mode (High Frequency Attenuation), the HF response of the system is rolled off. HFA provides a natural, balanced frequency response when a cabinet is placed close to listeners in near field or delay use.

High Frequency Attenuation begins gradually at 1 kHz, dropping by approximately 3 dB at 10 kHz. This roll off mimics the decline in frequency response experienced when listening to a system from a distance in a typically reverberant room or auditorium.

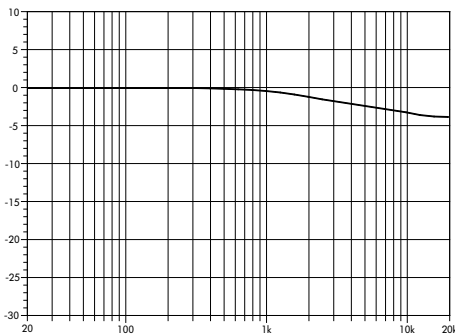

Frequency response correction in HFA mode

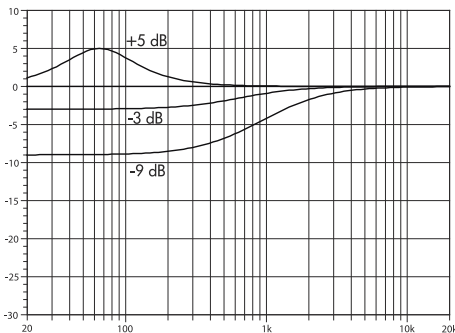

Frequency response correction of the CPL function

#### CPL function

The CPL (Coupling) function compensates for coupling effects between the cabinet and close boundary surfaces. CPL begins gradually around 1 kHz, with the maximum attenuation below 400 Hz. To achieve a balanced frequency response, the CPL function can be set to dB attenuation values between 0 and -9.

Positive CPL values create an adjustable low frequency boost (0 to +5 dB) at around 65 Hz and can be set when the system is used in full range mode without subwoofers.



## 2.4 Dispersion characteristics

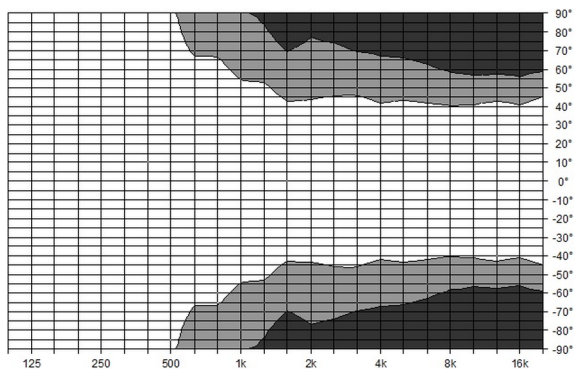

Isobar diagram horizontal



**Yi7P**  
vertical setup

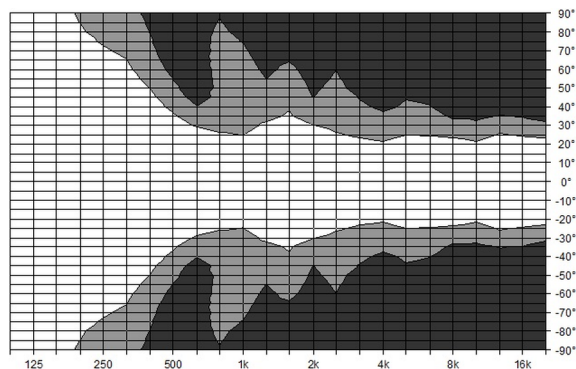

Isobar diagram vertical

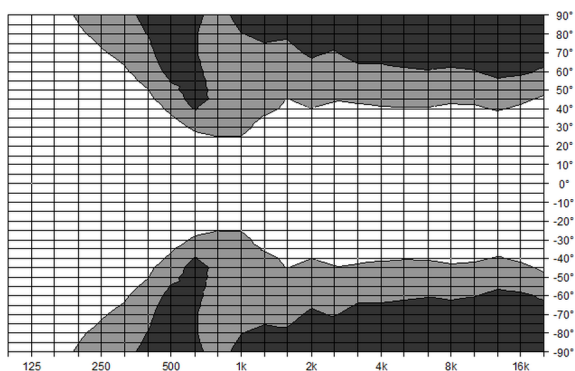

Isobar diagram horizontal

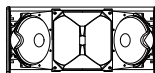

**Yi7P**  
horizontal setup,  
horn rotated

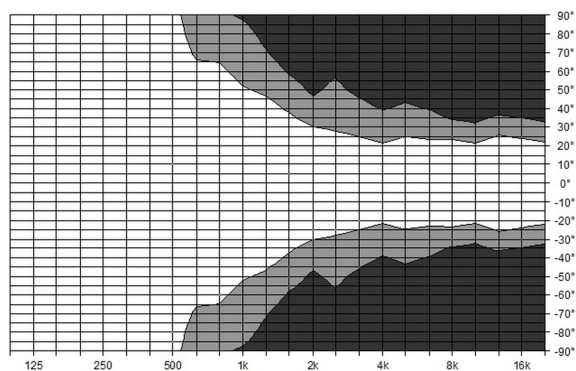

Isobar diagram vertical

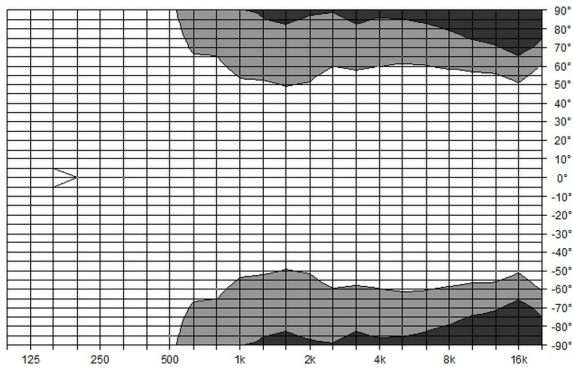

Isobar diagram horizontal



Yi10P

vertical setup

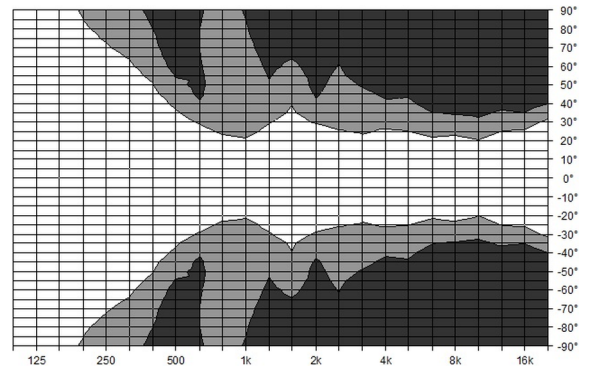

Isobar diagram vertical

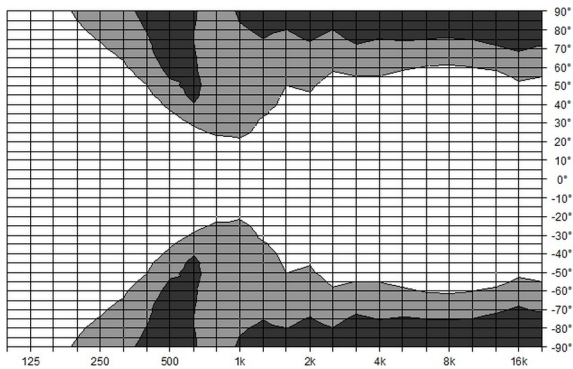

Isobar diagram horizontal

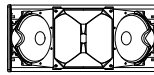

Yi10P

horizontal setup,  
horn rotated

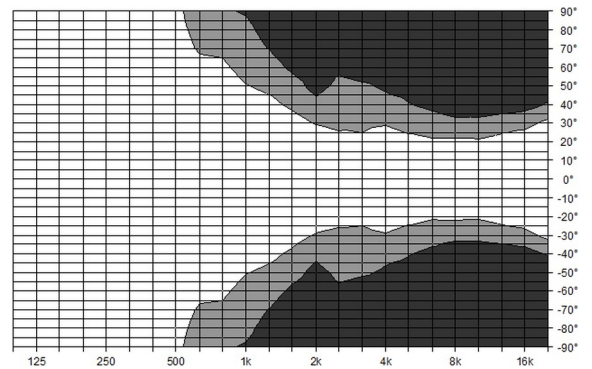

Isobar diagram vertical

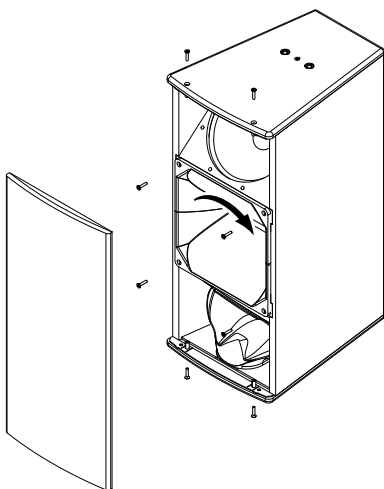
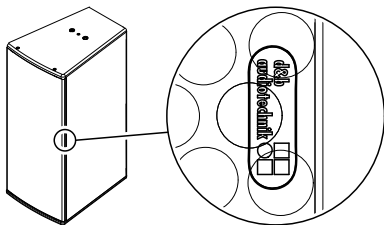

Altering the HF dispersion

### Altering the HF horn dispersion

By factory default, the HF horn is fitted to the cabinet providing the nominal horizontal dispersion when the cabinet is used in upright position. This is indicated by a white label on the horn flange. The label is visible through the front grill on each side of the cabinet as shown in the graphic opposite.

The HF horn can be rotated through 90°.

**Tools required:** Torx wrench (#TX20).

1. Undo the torx screws on the top and bottom panels of the cabinet and remove the front grill.
2. Undo the screws holding the horn flange and rotate the horn.
3. Refit the horn as follows:
  - Make sure the gasket of the horn is in place.
  - Refit the horn.
  - Insert all screws and carefully tighten them clockwise until they fit precisely into the countersunk holes.
4. Refit the front grill.

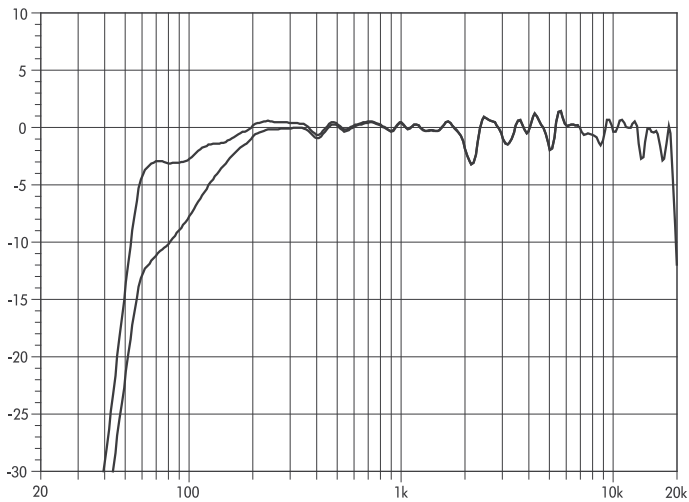

**Yi7P frequency response, standard and CUT modes**

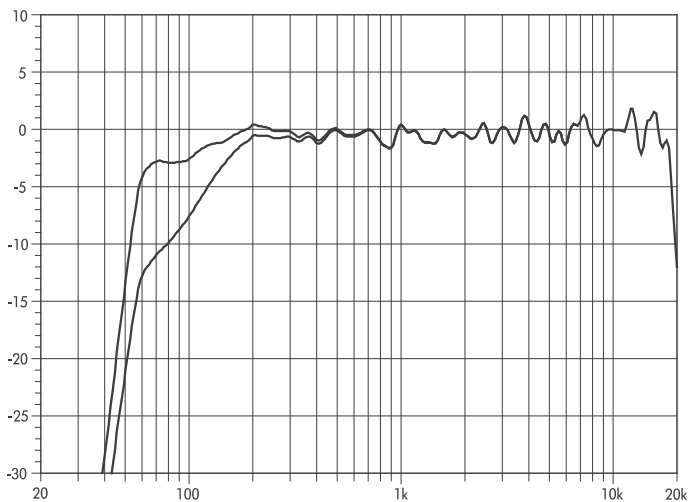

**Yi10P frequency response, standard and CUT modes**

## 2.5 Technical specifications

### Yi7P/Yi10P system data

Frequency response (-5 dB standard)	59 Hz - 18 kHz
Frequency response (-5 dB CUT mode)	118 Hz - 18 kHz
Max. sound pressure (1 m, free field)	
Yi7P with D6/10D	132 dB
Yi7P with D12/D20/30D	135 dB
Yi7P with D80	137 dB
Yi10P with D6/10D	131 dB
Yi10P with D12/D20/30D	134 dB
Yi10P with D80	136 dB
	(SPLmax peak, pink noise test signal with crest factor of 4)

### Yi7P/Yi10P loudspeaker

Nominal impedance	8 ohms
Power handling capacity (RMS/peak 10 ms)	400/1600 W
Nominal dispersion angle (horizontal) Yi7P	75°
Nominal dispersion angle (horizontal) Yi10P	110°
Nominal dispersion angle (vertical)	40°
Components	2 x 8" driver with neodymium magnet 1.4" exit compression driver Passive crossover network
Connections	2 x NL4 M 1 x screw terminal (ST - up to 4 mm <sup>2</sup> /AWG 11) WR option: Faston type connector (2 x 6,3mm)
Pin assignment	NL4 M: 1+/1- WR option: Brown: (+) / Blue: (-)
Weight	18 kg (40 lb)

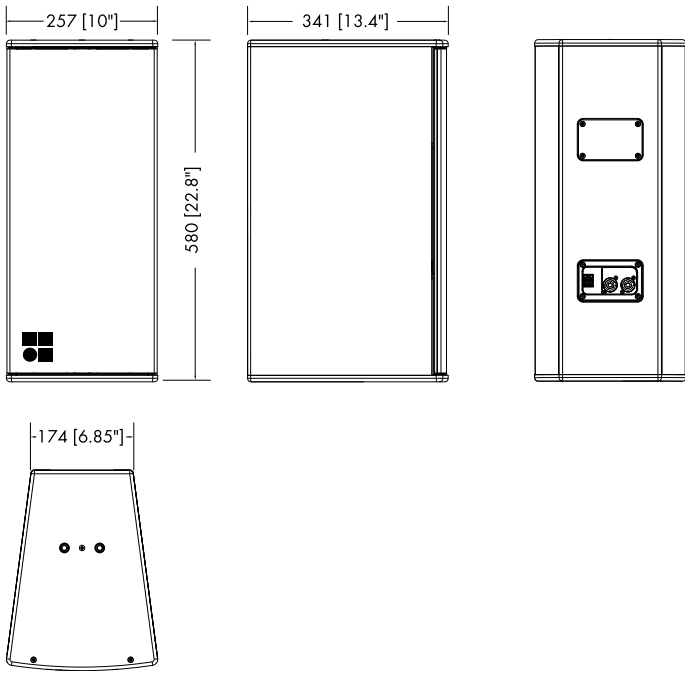

**Yi7P/Yi10P cabinet dimensions in mm [inch]**



### 3.1 EU conformity of loudspeakers (CE symbol)

This declaration applies to:

**d&b Yi7P loudspeaker, Z0712**

**d&b Yi10P loudspeaker, Z0713**

manufactured by d&b audiotechnik GmbH.

All production versions of these types are included, provided they correspond to the original technical version and have not been subject to any later design or electromechanical modifications.

We herewith declare that said products are in conformity with the provisions of the respective EC directives including all applicable amendments.

A detailed declaration is available on request and can be ordered from d&b or downloaded from the d&b website at [www.dbaudio.com](http://www.dbaudio.com).

#### 3.1.1 WEEE Declaration (Disposal)

Electrical and electronic equipment must be disposed of separately from normal waste at the end of its operational lifetime.

Please dispose of this product according to the respective national regulations or contractual agreements. If there are any further questions concerning the disposal of this product, please contact d&b audiotechnik.

